

Rover Series

Rover 20A | 30A | 40A



Maximum Power Point Tracking Solar Charge Controller



Important Safety Instructions

Please save these instructions.

This manual contains important safety, installation, and operating instructions for the charge controller. The following symbols are used throughout the manual to indicate potentially dangerous conditions or important safety information.

- | | |
|-----------------------------------------------------------------------------------|--------------------------------------------------------------------------------------------------------|
|  | Indicates a potentially dangerous condition. Use extreme caution when performing this task |
|  | Indicates a critical procedure for safe and proper operation of the controller |
|  | Indicates a procedure or function that is important to the safe and proper operation of the controller |

General Safety Information

- Read all of the instructions and cautions in the manual before beginning the installation.
- There are no serviceable parts for this controller. Do **NOT** disassemble or attempt to repair the controller.
- Do **NOT** allow water to enter the controller.
- Make sure all connections going into and from the controller are tight.

Charge Controller Safety

- **NEVER** connect the solar panel array to the controller without a battery. Battery must be connected first.
- Ensure input voltage does not exceed 100 VDC to prevent permanent damage. Use the Open Circuit Voltage (Voc) to make sure the voltage does not exceed this value when connecting panels together.

Battery Safety

- Use only sealed lead-acid, flooded, gel or lithium batteries which **must be deep cycle**.
- Explosive battery gases may be present while charging. Be certain there is enough ventilation to release the gases.
- Be careful when working with large lead acid batteries. Wear eye protection and have fresh water available in case there is contact with the battery acid.
- Carefully read battery manuals before operation.
- Do **NOT** let the positive (+) and negative (-) terminals of the battery touch each other.
- Recycle battery when it is replaced.
- Over-charging and excessive gas precipitation may damage the battery plates and activate material shedding on them. Too high of an equalizing charge or too long of one may cause damage. Please carefully review the specific requirements of the battery used in the system.
- Equalization is carried out only for non-sealed / vented/ flooded / wet cell lead acid batteries.
- Do **NOT** equalize VRLA type AGM / Gel / Lithium cell batteries UNLESS permitted by battery manufacturer.
- Default charging parameters in Li mode are programmed for 12.8V Lithium Iron Phosphate (LFP) Battery only. Before using Rover to charge other types of lithium battery, set the parameters according to the suggestions from battery manufacturer.

WARNING

Connect battery terminals to the charge controller BEFORE connecting the solar panel(s) to the charge controller. NEVER connect solar panels to charge controller until the battery is connected.

Do NOT connect any inverters or battery charger into the load terminal of the charge controller.

Once equalization is active in the battery charging, it will not exit this stage unless there is adequate charging current from the solar panel. There should be NO load on the batteries when in equalization charging stage.

Table of Contents

General Information	04
Additional Components	08
Optional Components	08
Identification of Parts	09
Installation	10
Operation	14
LED Indicators	18
Rover Protections	20
System Status Troubleshooting	21
Error Codes	21
Maintenance	22
Fusing	22
Technical Specifications	23
Electrical Parameters	23
General	23
Battery Charging Parameters	24
PV Power – Conversion Efficiency Curves	25
Dimensions	26

General Information

The Rover Series charge controllers are suitable for various off-grid solar applications. It protects the battery from being over-charged by the solar modules and over-discharged by the loads. The controller features a smart tracking algorithm that maximizes the energy from the solar PV module (s) and charge the battery. At the same time, the low voltage disconnect function (LVD) will prevent the battery from over discharging.

The Rover's charging process has been optimized for long battery life and improved system performance. The comprehensive self-diagnostics and electronic protection functions can prevent damage from installation mistakes or system faults.

Key Features

- Automatically detect 12V or 24V DC system voltages
- Innovative MPPT technology with high tracking efficiency up to 99% and peak conversion efficiency of 98%
- Deep cycle Sealed, Gel, Flooded and Lithium (12.8V LFP) battery option ready
- Electronic protection: Overcharging, over-discharging, overload, and short circuit
- Reverse protection: Any combination of solar module and battery, without causing damage to any component
- Customizable charging voltages
- Charges over-discharged lithium batteries
- RS232 port to communicate with BT-1 Bluetooth module and PC

MPPT Technology

The MPPT Charge Controller utilizes Maximum Power Point Tracking technology to extract maximum power from the solar module(s). The tracking algorithm is fully automatic and does not require user adjustment. MPPT technology will track the array's maximum power point voltage (Vmp) as it varies with weather conditions, ensuring that the maximum power is harvested from the array throughout the course of the day.

Current Boost

In many cases, the MPPT charge controller will "boost" up the current in the solar system. The current does not come out of thin air. Instead, the power generated in the solar panels is the same power that is transmitted into the battery bank. Power is the product of Voltage (V) x Amperage (A).

Therefore, assuming 100% efficiency:

$$\text{Power In} = \text{Power Out}$$
$$\text{Volts In} * \text{Amps In} = \text{Volts out} * \text{Amps out}$$

Although MPPT controllers are not 100% efficient, they are very close at about 92-95% efficient. Therefore, when the user has a solar system whose V_{mp} is greater than the battery bank voltage, then that potential difference is proportional to the current boost. The voltage generated at the solar module needs to be stepped down to a rate that could charge the battery in a stable fashion by which the amperage is boosted accordingly to the drop. It is entirely possible to have a solar module generate 8 amps going into the charge controller and likewise have the charge controller send 10 amps to the battery bank. This is the essence of the MPPT charge controllers and their advantage over traditional charge controllers. In traditional charge controllers, that stepped down voltage amount is wasted because the controller algorithm can only dissipate it as heat. The following demonstrates a graphical point regarding the output of MPPT technology.

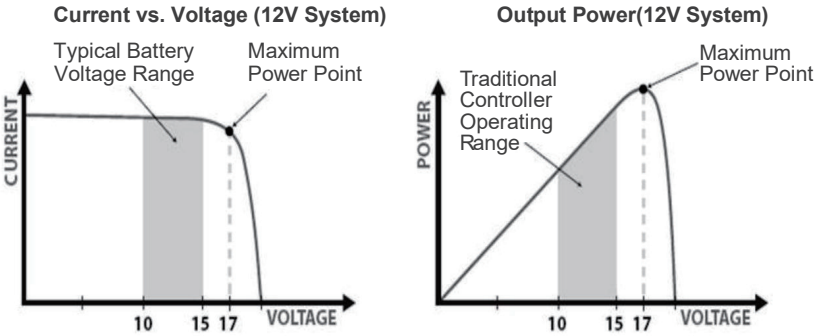

Limiting Effectiveness

Temperature is a huge enemy of solar modules. As the environmental temperature increases, the operating voltage (V_{mp}) is reduced and limits the power generation of the solar module. Despite the effectiveness of MPPT technology, the charging algorithm will possibly not have much to work with and therefore there is an inevitable decrease in performance. In this scenario, it would be preferred to have modules with higher nominal voltage, so that despite the drop in performance of the panel, the battery is still receiving a current boost because of the proportional drop in module voltage.

Four Charging Stages

The Rover MPPT charge controller has a 4-stage battery charging algorithm for a rapid, efficient, and safe battery charging. They include: Bulk Charge, Boost Charge, Float Charge, and Equalization.

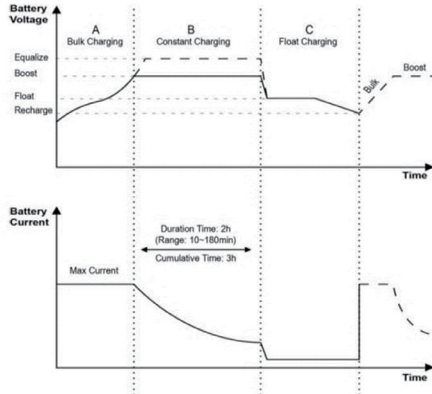

Bulk Charge: This algorithm is used for day to day charging. It uses 100% of available solar power to recharge the battery and is equivalent to constant current. In this stage the battery voltage has not yet reached constant voltage (Equalize or Boost), the controller operates in constant current mode, delivering its maximum current to the batteries (MPPT Charging) .

Constant Charging: When the battery reaches the constant voltage set point, the controller will start to operate in constant charging mode, where it is no longer MPPT charging. The current will drop gradually. This has two stages, equalize and boost and they are not carried out constantly in a full charge process to avoid too much gas precipitation or overheating of the battery.

- **Boost Charge:** Boost stage maintains a charge for 2 hours by default. The user can adjust the constant time and preset value of boost per their demand.

Float Charge: After the constant voltage stage, the controller will reduce the battery voltage to a float voltage set point. Once the battery is fully charged, there will be no more chemical reactions and all the charge current would turn into heat or gas. Because of this,

The charge controller will reduce the voltage charge to smaller quantity, while lightly charging the battery. The purpose for this is to offset the power consumption while maintaining a full battery storage capacity. In the event that a load drawn from the battery exceeds the charge current, the controller will no longer be able to maintain the battery to a Float set point and the controller will end the float charge stage and refer back to bulk charging.

⚠ Equalization: Is carried out every 28 days of the month. It is intentional overcharging of the battery for a controlled period of time. Certain types of batteries benefit from periodic equalizing charge, which can stir the electrolyte, balance battery voltage and complete chemical reaction. Equalizing charge increases the battery voltage, higher than the standard complement voltage, which gasifies the battery electrolyte.

WARNING

Once equalization is active in the battery charging, it will not exit this stage unless there is adequate charging current from the solar panel. There should be NO load on the batteries when in equalization charging stage.

WARNING

Over-charging and excessive gas precipitation may damage the battery plates and activate material shedding on them. Too high of equalizing charge or for too long may cause damage. Please carefully review the specific requirements of the battery used in the system.

WARNING

Equalization may increase battery voltage to a level damaging to sensitive DC loads. Ensure that all load allowable input voltages are greater than the equalizing charging set point voltage.

Lithium Battery Activation

The Rover MPPT charge controller has a reactivation feature to awaken a sleeping lithium battery. The protection circuit of lithium battery will typically turn the battery off and make it unusable if over-discharged. This can happen when storing a lithium battery pack in a discharged state for any length of time as self-discharge would gradually deplete the remaining charge. Without the wake-up feature to reactivate and recharge batteries, these batteries would become unserviceable and the packs would be discarded. The Rover will apply a small charge current to activate the protection circuit and if a correct cell voltage can be reached, it starts a normal charge.

CAUTION

When using the Rover to charge a 24V lithium battery bank, set the system voltage to 24V instead of auto recognition. If auto recognition is accidentally selected the Rover will allow you to change it to 24V when the lithium battery activation feature is activated. In the activation interface press and hold the enter button to trigger the system voltage selector. To change the system voltage, press the Up or Down buttons then long press Enter to save the selected system voltage.

Additional Components

Additional components included in the package:



Remote Temperature Sensor:

This sensor measures the temperature at the battery and uses this data for very accurate temperature compensation. Accurate temperature compensation is important in ensuring proper battery charging regardless of the temperature.

NOTE

Do Not use this sensor when charging lithium battery.

Optional Components

Optional components that require a separate purchase:



Renogy BT-1 Bluetooth Module:

The BT-1 Bluetooth module is a great addition to any Renogy charge controllers with a RS232 port and is used to pair charge controllers with the Renogy BT App. After pairing is done you can monitor your system and change parameters directly from you cell phone or tablet. No more wondering how your system is performing, now you can see performance in real time without the need of checking on the controller's LCD.

Identification of Parts

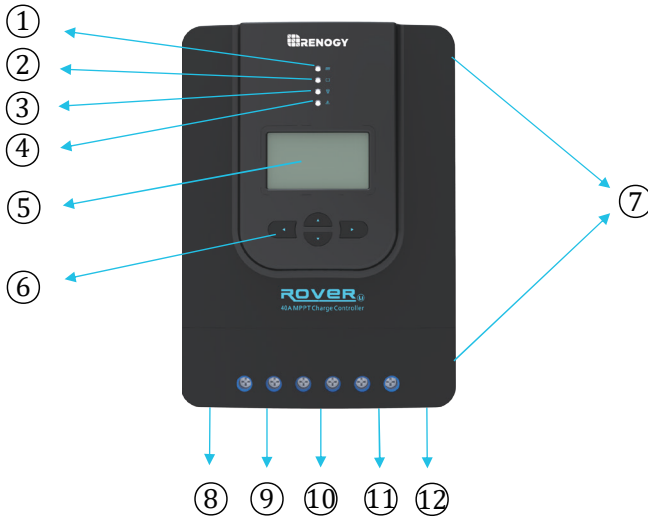

■ Key Parts

1. PV LED Indicator
2. Battery LED Indicator
3. Load LED Indicator
4. System Error LED Indicator
5. LCD Screen
6. Operating Keys
7. Mounting Holes
8. Remote Temperature Sensor Port (optional accessory)
9. PV Terminals
10. Battery Terminals
11. Load Terminals
12. RS-232 Port (optional accessory)

Installation

Recommended tools to have before installation:

Screwdriver	Multi-Meter
	

WARNING

Connect battery terminal wires to the charge controller **FIRST** then connect the solar panel(s) to the charge controller. **NEVER** connect solar panel to charge controller before the battery.

WARNING

Do **NOT** connect any inverters or battery chargers into the **LOAD TERMINAL** of the charge controller.

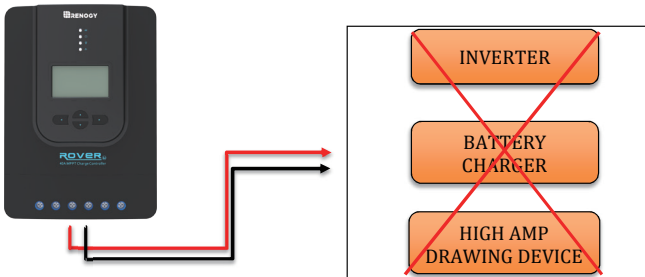

CAUTION

Do not over tighten the screw terminals. This could potentially break the piece that holds the wire to the charge controller.

CAUTION

Refer to the technical specifications for max wire sizes on the controller and for the maximum amperage going through wires.

You are now ready to begin connecting your battery to your charge controller.

Battery

1

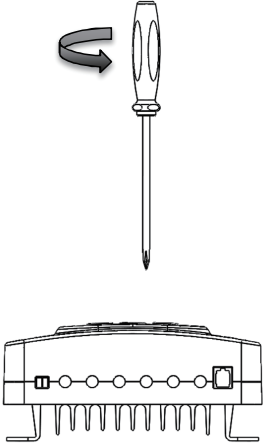

2

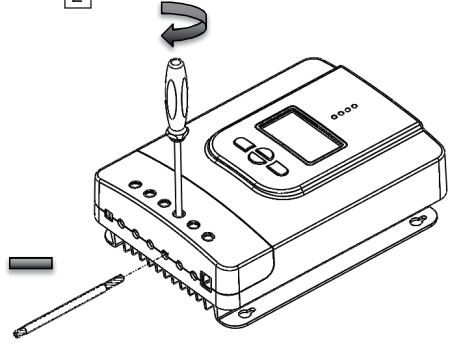

3

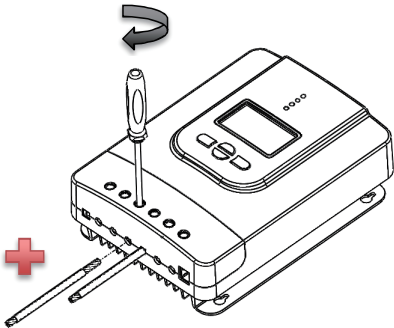

Load (optional)

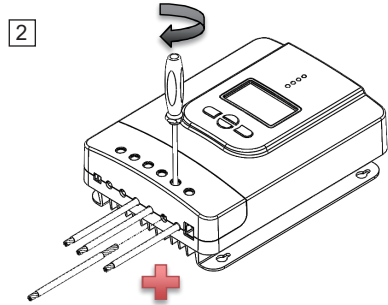
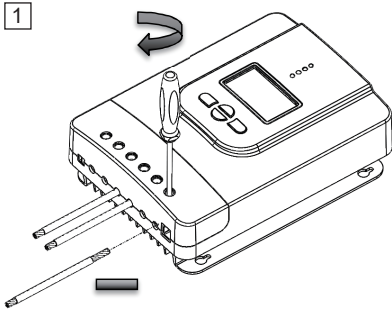

Solar Panels

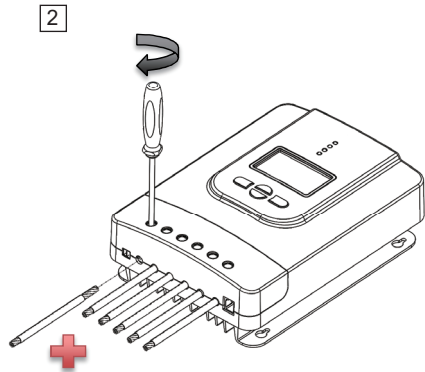
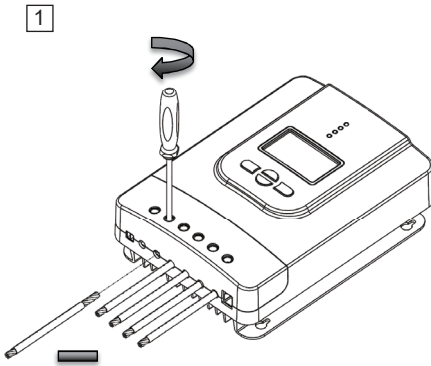

PC or Bluetooth Module communication (optional)

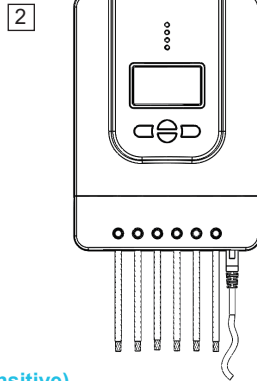
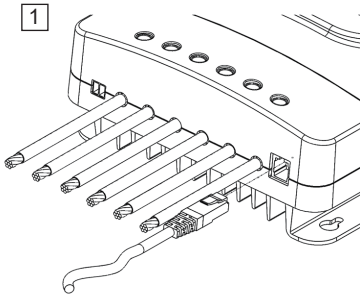

Temperature Sensor (optional, not polarity sensitive)

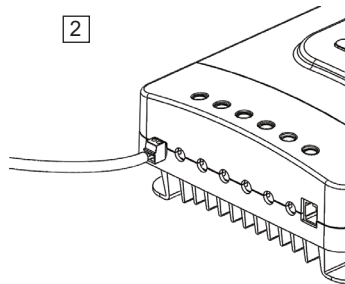
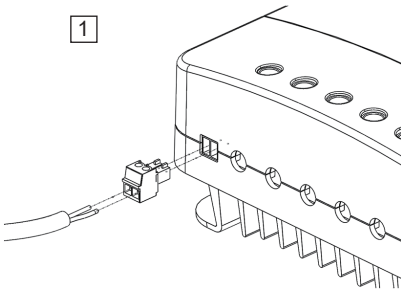

3 Secure the Temperature Sensor lug to one of the battery posts

NOTE

Do NOT place the Temperature Sensor lug inside the battery cell.

Mounting Recommendations

WARNING

Never install the controller in a sealed enclosure with flooded batteries. Gas can accumulate and there is a risk of explosion.

1. Choose Mounting Location—place the controller on a vertical surface protected from direct sunlight, high temperatures, and water. Make sure there is good ventilation.

-
- 2. Check for Clearance**—verify that there is sufficient room to run wires, as well as clearance above and below the controller for ventilation. The clearance should be at least 6 inches (150mm).
 - 3. Mark Holes**
 - 4. Drill Holes**
 - 5. Secure the charge controller.**

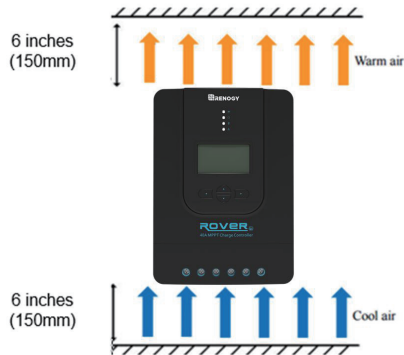

Operation

Rover is very simple to use. Simply connect the batteries, and the controller will automatically determine the battery voltage. The controller comes equipped with an LCD screen and 4 buttons to maneuver through the menus.

Startup Interface

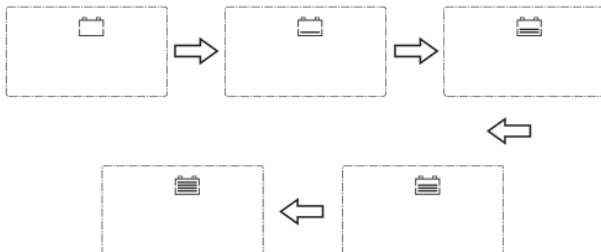



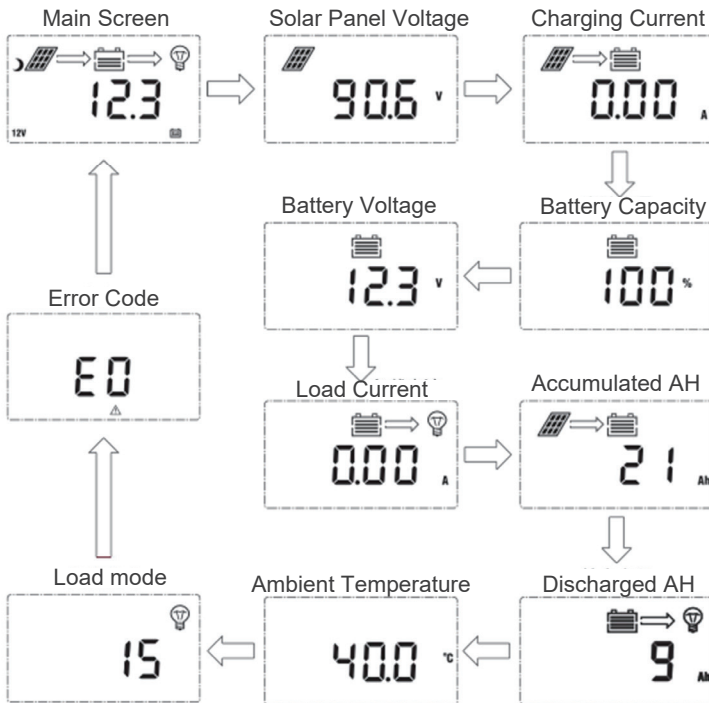

Main Display

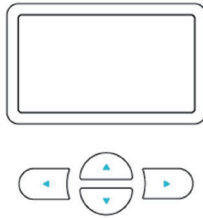

NOTE

The Battery Capacity (SOC%) is an estimation based on the charging voltage.



	Page Up/ Increase parameter value
	Page Down/ Decrease parameter value
	Return to the previous menu
	Enter sub menu/ save parameter value/ turn load on or off in manual mode

Programming Parameters

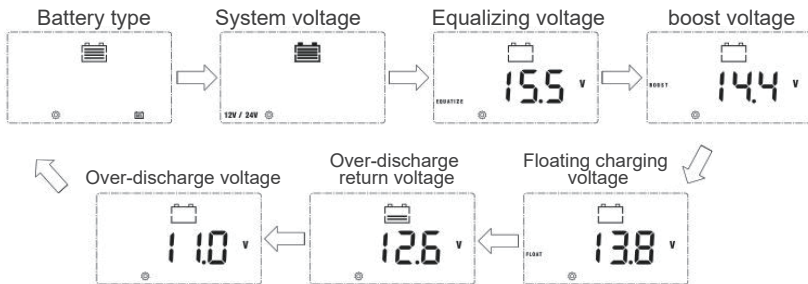

To enter the programming interface simply press and hold the right arrow button. After entering this feature press the Enter/Right button to switch between parameters. To change the parameters, press the Up or Down button. To save the parameter press and hold the Enter/Right button.

The charging parameter setting (Equalizing voltage, Boost voltage, Floating charging voltage, over-discharge return voltage, Over-discharge voltage) are only available under the battery “USER” mode. Press and hold the right arrow to enter the programming settings and continue pressing the right arrow button until you see the desired voltage screen.

NOTE

Battery charging parameters can also be programmed using Solar Monitoring Software and Renogy BT APP. Read the corresponding user manuals for more information.

Programming Load Terminal

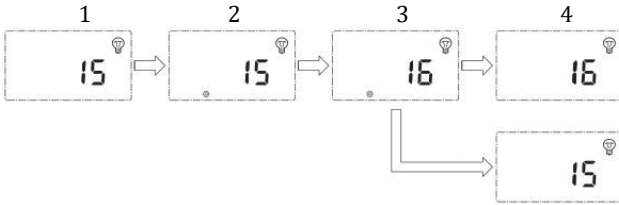

1. This screen is displaying the current Load Mode.
2. To enter screen 2 and hold the Enter button. This screen will allow you to change the load mode.
3. To change the load mode press the up or down button.
4. Once you have selected the desired load mode press the Enter button to save the setting.
5. To exit the programming setting press the left button.

Load Mode Options





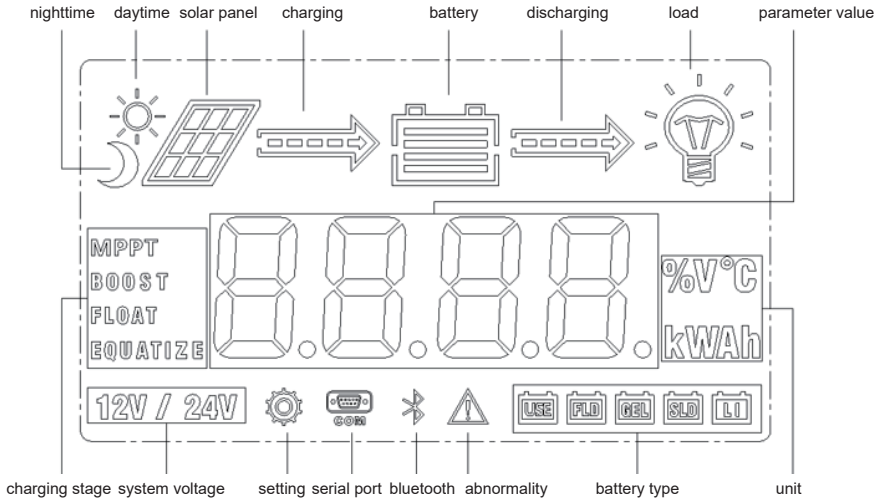



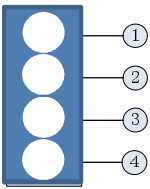





Setting	Mode	Description
0	Automatic(On/Off)	The load will turn on at night when the solar panel is no longer producing any power after a short time delay. The load will turn off when the panel starts producing power.
1-14	Time control	When the panel is no longer producing power the load will be ON for 1-14 hours or until the panel starts producing power.
15	Manual	In this mode, the user can turn the Load On/Off by pressing the Enter button at any time.
16	Test	Used to troubleshoot load terminal (No Time Delay). When voltage is detected load will be off and when no voltage is detected load will be on.
17	24Hr	The load will be on for 24 hours a day.

LCD Indicators



LED Indicators

	①---PV array indicator	Indicating the controller's current charging mode.
	②---BAT indicator	Indicating the battery's current state.
	③---LOAD indicator	Indicating the loads' On/ Off state.
	④---ERROR indicator	Indicating whether the controller is functioning normally.

PV Indicator (1)		Status
	White Solid	The PV system is <u>charging</u> the battery bank
	White Slow Flashing	The Controller is undergoing boost stage
	White Single Flashing	The Controller is undergoing float stage
	White Fast Flashing	The Controller is undergoing equalization stage
	White Double Flashing	The PV system is <u>charging</u> the battery bank at a slow rate. Make sure panels are not shaded. Low Amperage
	Off	The PV system is <u>not charging</u> the battery bank. PV not detected.
BATT Indicator (2)		Status
	White Solid	Battery is <u>normal</u>
	White Slow Flashing	Battery <u>over-discharged</u>
	White Fast Flashing	Battery <u>over-voltage</u>
BATT Indicator (3)		Status
	White Solid	Load is <u>on</u>
	White Fast Flashing	Load is <u>over-loaded</u> or <u>short-circuited</u>
	Off	Load is <u>off</u>
BATT Indicator (4)		Status
	White Solid	System Error. Please check LCD for Error code
	Off	System is operating normally

Rover Protections

Protection	Behavior
PV Array Short Circuit	When PV short circuit occurs, the controller will stop charging. Clear it to resume normal operation.
PV Overvoltage	If the PV voltage is larger than maximum input open voltage 100VDC, PV will remain disconnected until the voltage drops below 100VDC.
PV Overcurrent	The controller will limit the battery charging current to the maximum battery current rating. Therefore, an over-sized solar array will not operate at peak power.
Load Overload	If the current exceeds the maximum load current rating 1.05 times, the controller will disconnect the load. Overloading must be cleared up by reducing the load and restarting the controller.
Load Short Circuit	Fully protected against the load wiring short-circuit. Once the load short (more than quadruple rated current), the load short protection will start automatically. After 5 automatic load reconnect attempts, the faults must be cleared by restarting the controller.
PV Reverse Polarity	The controller will not operate if the PV wires are switched. Wire them correctly to resume normal controller operation.
Battery Reverse Polarity	The controller will not operate if the battery wires are switched. Wire them correctly to resume normal controller operation.
Over-Temperature	If the temperature of the controller heat sink exceeds 65°C, the controller will automatically start reducing the charging current and shut down when temperature exceeds 80°C.

System Status Troubleshooting

PV Indicator	Troubleshoot
Off during daylight	Ensure that the PV wires are correctly and tightly secured inside the charge controller PV terminals. Use a multi-meter to make sure the poles are correctly connected to the charge controller.
BATT Indicator	Troubleshoot
White Slow Flashing	Disconnect loads, if any, and let the PV modules charge the battery bank. Use a multi-meter to frequently check on any change in battery voltage to see if condition improves. This should ensure a fast charge. Otherwise, monitor the system and check to see if system improves.
White Fast Flashing	Using a multimeter check the battery voltage and verify it is not exceeding 32 volts.
Load Indicator	Troubleshoot
White Fast Flashing	The Load circuit on the controller is being shorted or overloaded. Please ensure the device is properly connected to the controller and make sure it does not exceed 20A (DC).
Error Indicator	Troubleshoot
WhiteSolid	System Error. Please check LCD for Error code

Error Codes

Error Number	Description
E0	No error detected
E1	Battery over-discharged
E2	Battery over-voltage
E3	Battery under-voltage
E4	Load short circuit
E5	Load overloaded
E6	Controller over-temperature
E8	PV input over-current
E10	PV over-voltage
E13	PV reverse polarity

Maintenance

WARNING

Risk of Electric Shock! Make sure that all power is turned off before touching the terminals on the charge controller.

For best controller performance, it is recommended that these tasks be performed from time to time.

1. Check that controller is mounted in a clean, dry, and ventilated area.
2. Check wiring going into the charge controller and make sure there is no wire damage or wear.
3. Tighten all terminals and inspect any loose, broken, or burnt up connections.
4. Make sure LED readings are consistent. Take necessary corrective action.
5. Check to make sure none of the terminals have any corrosion, insulation damage, high temperature, or any burnt/discoloration marks.

Fusing

Fusing is a recommended in PV systems to provide a safety measure for connections going from panel to controller and controller to battery. Remember to always use the recommended wire gauge size based on the PV system and the controller.

NEC Maximum Current for different Copper Wire Sizes									
AWG	16	14	12	10	8	6	4	2	0
Max. Current	18A	25A	30A	40A	55A	75A	95A	130A	170A

Note: The NEC code requires the overcurrent protection shall not exceed 15A for 14AWG, 20A for 12 AWG, and 30A for 10AWG copper wire.

Fuse from Controller to Battery

Controller to Battery Fuse = Current Rating of Charge Controller

Ex. 20A MPPT CC = 20A fuse from Controller to Battery

Fuse from Solar Panel(s) to Controller

Ex. 200W; 2 X 100 W panels

****Utilize 1.56 Sizing Factor (SF)**

NOTE

Different safety factors could be used. The purpose is to oversize.

Series:

Total Amperage = $I_{sc1} + I_{sc2} * SF$

= $5.75A * 1.56 = 8.97$

Fuse = 9A fuse

Parallel

Total Amperage = $(I_{sc1} + I_{sc2}) * SF$

= $(5.75A + 5.75A) * 1.56 = 17.94$

Fuse = 18A fuse

Technical Specifications

Electrical Parameters

Model	RVR-20	RVR-30	RVR-40
Nominal system voltage	12V/24V Auto Recognition		
Rated Battery Current	20A	30A	40A
Rated Load Current	20A	20A	20A
Max. Battery Voltage	32V		
Max Solar Input Voltage	100 VDC		
Max. Solar Input Power	12V @ 260W	12V @ 400W	12V @ 520W
	24V @ 520W	24V @ 800W	24V @ 1040W
Self-Consumption	≤100mA @ 12V ≤58mA @ 24V		
Charge circuit voltage drop	≤ 0.26V		
Discharge circuit voltage drop	≤ 0.15V		
Temp. Compensation	-3mV/°C/2V (default)		

General

Model	RVR-20	RVR-30/40
Dimensions	210 x 151 x 59.5mm 8.27 x 5.94 x 2.34in	238 x 173 x 72.5mm 9.37 x 6.81 x 2.85in
Mounting Oval	7.66 x 4.70mm 0.30 x 0.18in	
Max Terminal Size	10mm ² 8 AWG	10mm ² 8 AWG
Net Weight	1.4kg 3.08 lb.	2.0kg 4.41 lb.
Working Temperature	-35°C to +45°C	
Storage Temperature	-35°C to +75°C	
Rated Load Current	10% to 90% NC	
Humidity Range	≤ 95% (NC)	
Enclosure	IP32	
Altitude	< 3000m	
Communication	RS232	
Certification	FCC Part 15 Class B; CE; RoHS; RCM	

This equipment has been tested and found to comply with the limits for a class B digital device, pursuant to part 15 of the FCC Rules. These limits are designed to provide reasonable protection against harmful interference in a residential installation. This equipment generates, uses and can radiate radio frequency energy and if not installed and used in accordance with the instructions, may cause harmful interference to radio communications. However, there is no guarantee that interference will not occur in a particular installation. If this equipment does cause harmful interference to radio or television reception, which can be determined by turning the equipment off and on, the user is encouraged to try to correct the interference by one or more of the following measures:

- Reorient or relocate the receiving antenna.
- Increase the separation between the equipment and receiver.
- Connect the equipment into an outlet on a circuit different from that to which the receiver is connected.
- Consult the dealer or an experienced radio/TV technician for help.

This device complies with Part 15 of the FCC Rules. Operation is subject to the following two conditions: (1) this device may not cause harmful interference, and (2) this device must accept any interference received, including interference that may cause undesired operation.

Battery Charging Parameters

Battery	GEL	SEALED	FLOODED	LI (LFP)	USER
High Voltage Disconnect	16 V	16 V	16 V	16 V	9-17 V
Equalization Voltage	----	14.6 V	14.8V	----	9-17 V
Boost Voltage	14.2 V	14.4 V	14.6 V	14.4 V	9-17 V
Float Voltage	13.8 V	13.8 V	13.8 V	----	9-17 V
Boost Return Voltage	13.2 V	13.2 V	13.2 V	13.2 V	9-17 V
Low Voltage Reconnect	12.6 V	12.6 V	12.6 V	12.6 V	9-17 V
Under Voltage Warning	12 V	12 V	12 V	12 V	9-17 V
Low Voltage Disconnect	11.0V	11.0V	11.0V	11.0V	9-17 V
Discharging Limit Voltage	10.6 V	10.6 V	10.6 V	10.6 V	9-17 V
Equalization Duration	----	2 hours	2 hours	----	0-10 Hrs.
Boost Duration	2 hours	2 hours	2 hours	----	1-10 Hrs.

*Battery charging parameters in LI mode and USER mode can be programmed using the Solar Monitoring Software or Renogy BT App.

**Default charging parameters in LI mode are programmed for 12.8V LFP battery. Before using Rover to charge other types of lithium battery, set the parameters according to the suggestions from battery manufacturer.

***Parameters are multiplied by 2 for 24V systems.

PV Power – Conversion Efficiency Curves

Illumination Intensity: 1000W/ m²

Temp 25 C

1.12 Volt System Conversion Efficiency

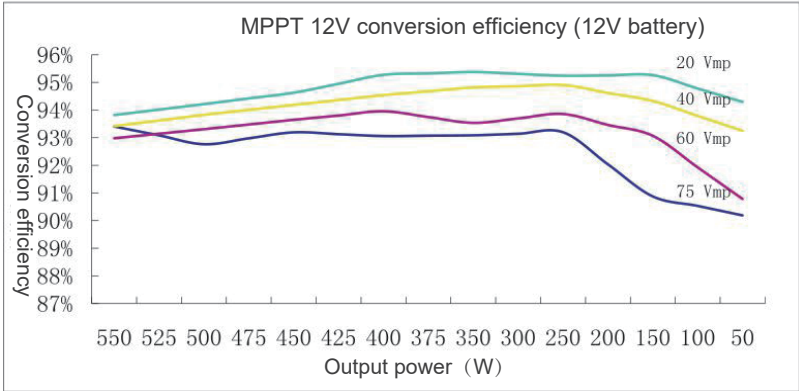

2. 24 Volt System Conversion Efficiency

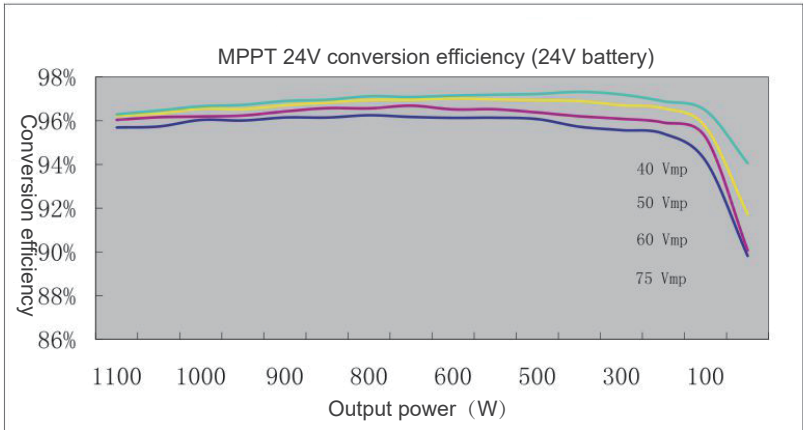

Dimensions

RVR-20

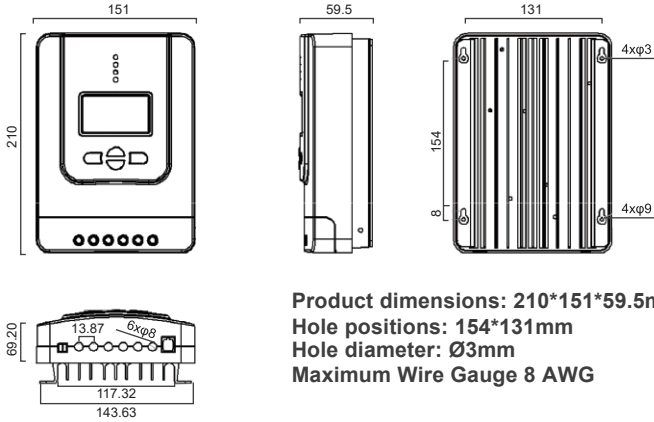

Product dimensions: 210*151*59.5mm
Hole positions: 154*131mm
Hole diameter: Ø3mm
Maximum Wire Gauge 8 AWG

NOTE

Dimensions in millimeters (mm)

RVR-30/40

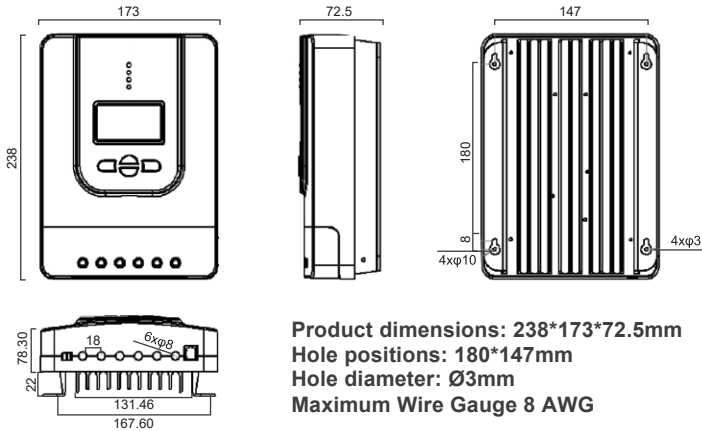

Product dimensions: 238*173*72.5mm
Hole positions: 180*147mm
Hole diameter: Ø3mm
Maximum Wire Gauge 8 AWG

NOTE

Dimensions in millimeters (mm)



2775 E. Philadelphia St., Ontario, CA 91761

1-800-330-8678

Renogy reserves the right to change the contents of this manual without notice.